



NATIONAL
MULTIPLE SCLEROSIS
SOCIETY

Staying Well

Stretching for People with MS

An Illustrated Manual

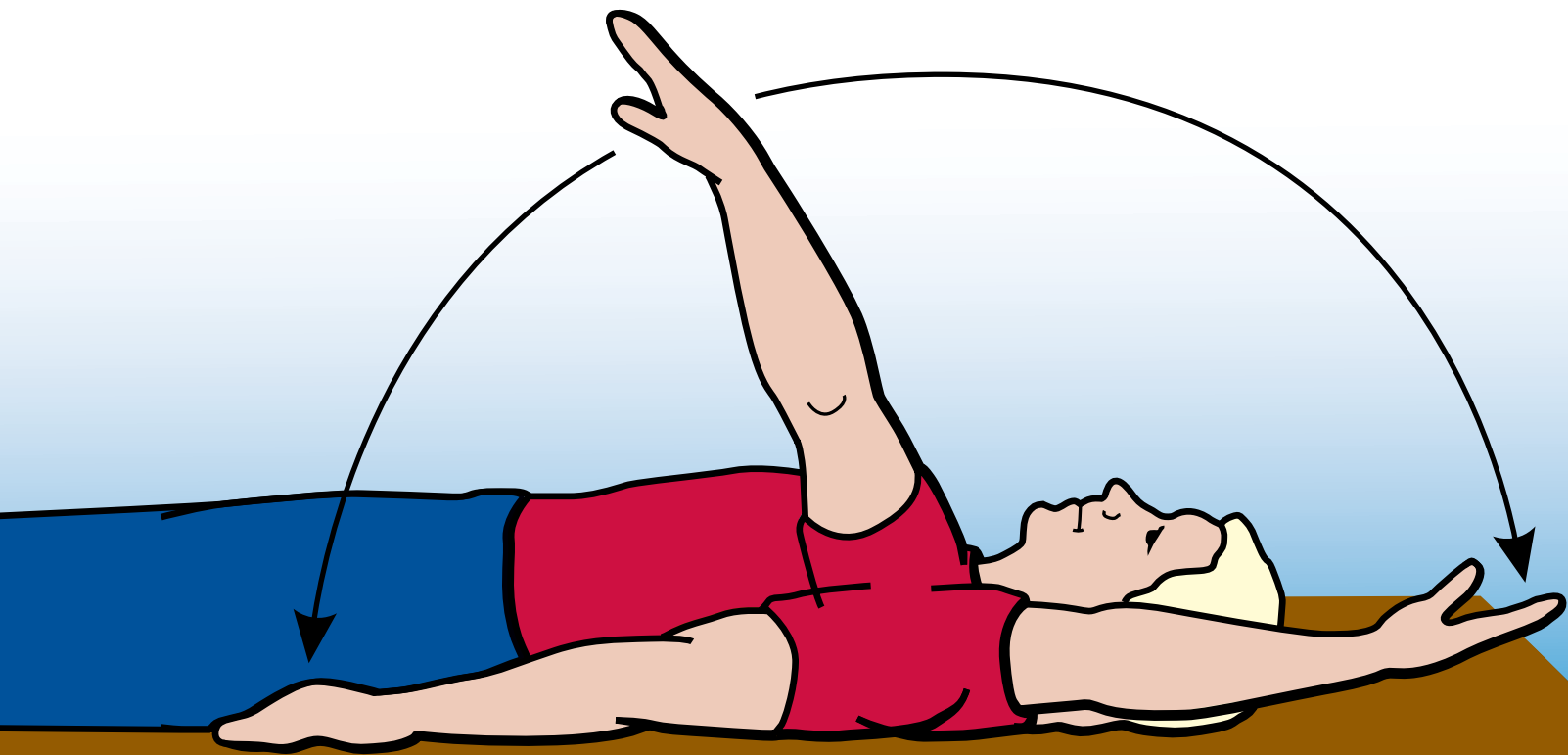

For Information: 1-800-344-4867 • nationalmssociety.org

Beth E. Gibson, PT, has a certificate in physical therapy from the Mayo School of Health Related Science in Rochester, Minnesota. She has been working with people with MS for 11 years.

Special thanks to Susan Kushner, MS, PT, and Cinda Hugos, MS, PT, for their valuable assistance.

*Drawings by iMageWorx. Some of these drawings originally appeared in **Multiple Sclerosis: A Self-Care Guide to Wellness**, published in 1998 by Paralyzed Veterans of America, Inc. They are reproduced here with the kind permission of PVA, Inc.*

Reviewed by members of the Client Education Committee of the National Multiple Sclerosis Society's Medical Advisory Board.

© 2007 National Multiple Sclerosis Society

Stretching for People with MS

An Illustrated Manual

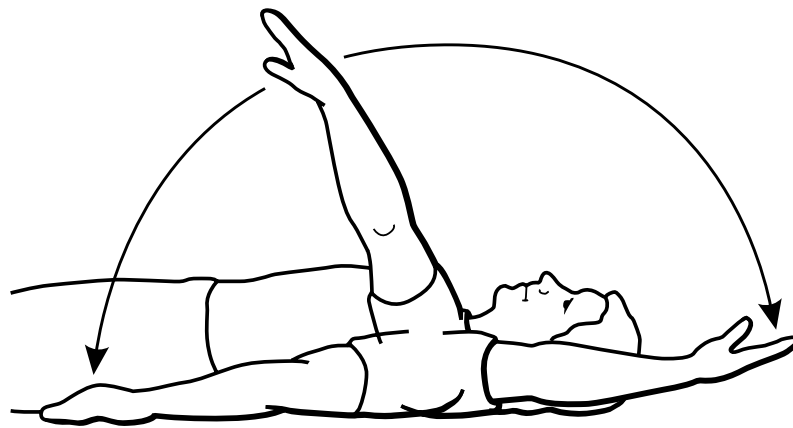

by Beth E. Gibson, PT

TABLE OF CONTENTS

GENERAL INTRODUCTION.....	3
SOME PRECAUTIONS, BOTH OBVIOUS AND NOT SO OBVIOUS.....	5
HEAD AND NECK EXERCISES	6
SHOULDER EXERCISES	
BASIC.....	7
AS A FLOW.....	9
ELBOW AND FOREARM EXERCISES	10
HAND AND WRIST EXERCISES.....	11
TRUNK AND HIP EXERCISES	14
ANKLE AND FOOT EXERCISES.....	17
SITTING COORDINATION AND BALANCE	19
POSITIONING FOR SPASTICITY	20
INDEX OF SPECIAL TERMS.....	24

GENERAL INTRODUCTION

Everyone with MS, regardless of his or her degree of ability or disability, needs regular physical activity. Lack of exercise has serious health consequences, ranging from constipation to increasing the risk of heart disease. Just as important, good exercise programs not only prevent problems, they promote a sense of achievement and well-being.

This booklet focuses on basics to move and gently stretch muscles and tendons, on your own, at your own pace. For the purposes of this book, the familiar term “stretching” is used, though most of these exercises are, technically, range of motion activities. Exercise can be broken down into five categories, one of which is relaxation. All are important to people with MS.

Flexibility—stretching the muscle and tendon to its full length and moving the joint through its full range. These activities decrease muscle tightness and prevent loss of full range of motion which may occur with decreased activity, weakness, or spasticity. Unaddressed, such loss can lead to joint contractures that painfully “freeze” joints into a single position.

Strengthening—increasing the force or power of the muscle. Strength can be increased by lifting a limb up against gravity, lifting weights, or by working against resistance such as walls, weights, or rubber tubing. Strengthening exercises can help reduce fatigue.

Endurance—improving heart and lung function. Aerobic exercise makes the heart and lungs work harder and builds endurance, reduces the risk of heart disease, and helps manage weight and cholesterol levels. Walking, swimming, or using a stationary bike are forms of endurance activities.

Balance and coordination—improving quality and safety of movement. Rhythmic hand or foot exercises and specific standing activities, usually with directions from a physical therapist, can improve balance and coordination.

GENERAL INTRODUCTION

Relaxation—reducing physical and mental tension. Relaxation can just mean stopping and taking a deep breath or sitting while listening to soft music. Structured relaxation techniques can reduce fatigue from an exercise session or help manage a stressful day. The National MS Society’s booklet “Taming Stress in MS” contains directions for several kinds of structured relaxation exercises.

SOME PRECAUTIONS, BOTH OBVIOUS AND NOT SO OBVIOUS

1. Wear clothing that doesn't restrict movement.
2. Be sure the room temperature is comfortably cool. Consider a fan, air conditioner, or open window. If you are especially heat-sensitive, consider a 10-minute soak in a cool tub before exercising. (Start with lukewarm water, slowly adding cooler water until the tub feels like a cool swimming pool.) Or experiment with cooling headbands, vests, or neck wraps.
3. Don't force any part of the body. If pain occurs, stop. Check with your health-care professional before trying that move again. If discomfort occurs, cut back to a motion that's easier.
4. Go slowly. All movements should be done evenly, allowing the muscles time to respond to the stretch by relaxing. Moving quickly can increase spasticity or stiffness. Try to hold each stretch for 60 seconds at the comfortable far end of your range. It may help to count out loud. Then gently return to the starting position.
5. Feel your way to more challenge. The idea is to increase the range of pain-free motion. Therefore, it's important to distinguish between pain and the feeling of stretch. Stretch is okay; pain is not.
6. If one side is weaker, use the stronger side to move the weaker side. A physician or physical therapist should be able to help you with this.
7. Remember to breathe evenly and relax the face throughout each movement. There's a tendency to grimace or hold the breath during an unusual movement.
8. Avoid overexertion. Include rest periods, and sip cool water to prevent overheating or dehydration.
9. Experiment with times of day. Some people find early morning best; some find it helpful to break exercise sessions into two parts: one in the morning, and the other in the afternoon or evening.

HEAD AND NECK EXERCISES

Exercise 1

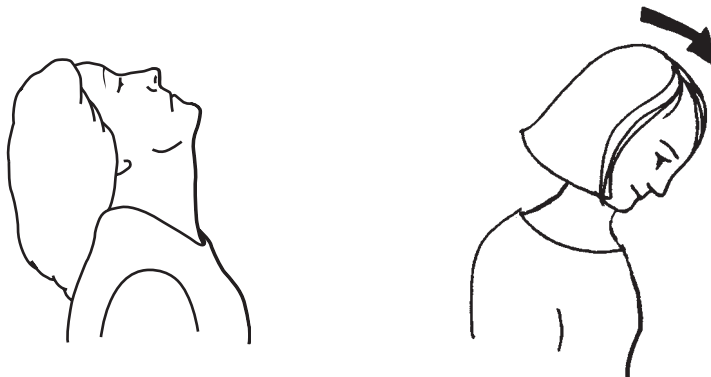

Bend head back (looking up). Do slowly; do not thrust head back quickly. Shoulders should be lowered and relaxed.

Bend head forward (looking down). **See CAUTION below.**

Exercise 2

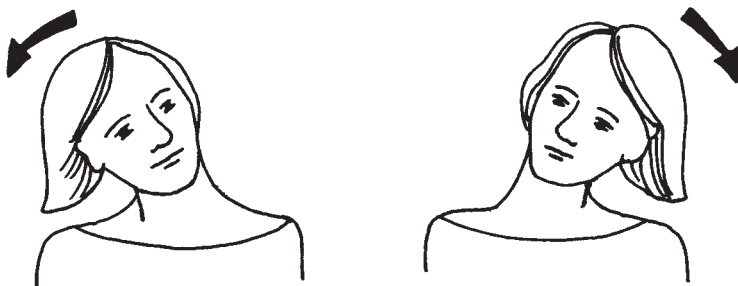

Bend head so that ear is moved toward shoulder.

Exercise 3

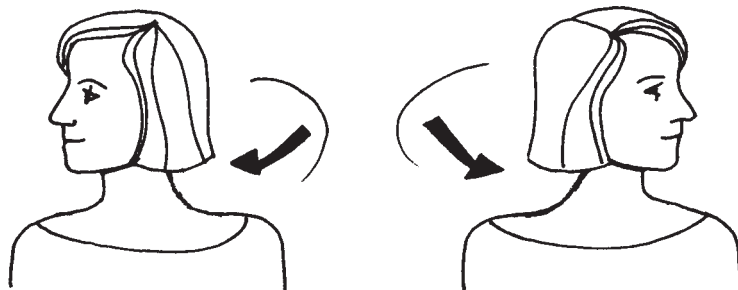

Turn head to look over shoulder.

CAUTION

Vertigo: This is dizziness or a “spinning of the room” sensation. If this movement makes you dizzy, light-headed, or nauseated, stop immediately and check with your physician.

Lhermitte’s sign: This is a tingling or electric shock–like sensation in the spine or limbs upon bending the neck, which sometimes occurs in MS. If you feel this sensation, discontinue this exercise and check with your physician.

SHOULDER EXERCISES—BASIC

Exercise 1

Starting position: Lie on your back with arms at your sides, palms up.

Raise one arm up over your head (as if raising your hand in class), keeping elbow and forearm straight. Hold for one deep in-and-out breath.

Return arm to starting position and repeat 2–3 times.

Repeat exercise with other arm.

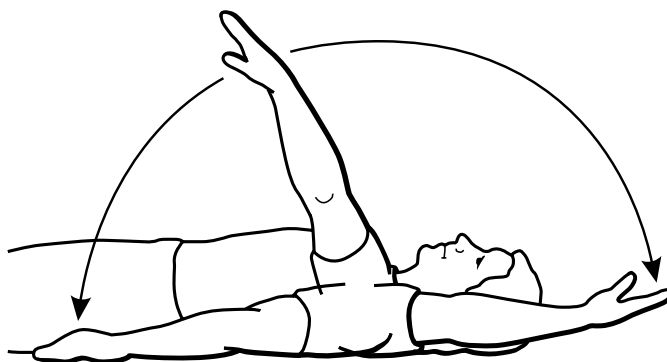

Exercise 2

Starting position: Lie on your back with arms at your sides. Turn your palms up.

Bring one arm out to the side and smoothly up to the side of your head (as if doing a one-armed jumping jack).

Return arm to starting position and repeat 2–3 times.

Repeat exercise with other arm.

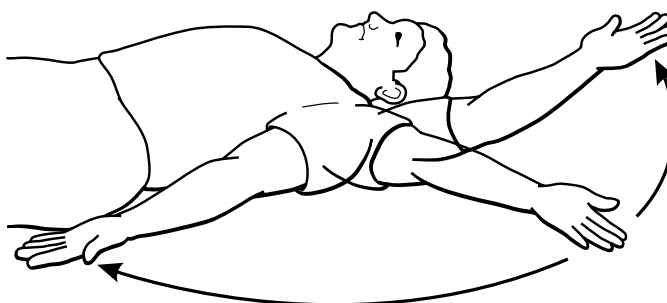

SHOULDER EXERCISES—BASIC

Exercise 3

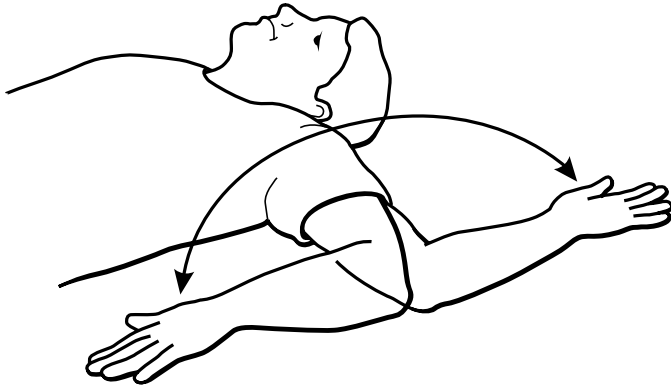

Starting position: Lie on your back with arm out at your side and your elbow bent at a 90-degree angle. Turn your palm down.

Raise your forearm up and over until the back of your palm touches the bed.

Gently return forearm to starting position, palm down on the bed. Repeat 2–3 times.

Repeat exercise with other arm.

Exercise 4

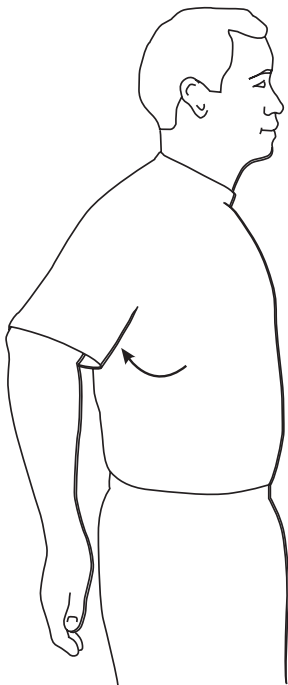

Starting position: Stand or sit in a chair.

Move arm straight back, as if reaching for something in your rear pocket. Allow forearm to dangle.

Return arm to starting position. Repeat 2–3 times.

Repeat exercise with other arm.

SHOULDER EXERCISES—AS A FLOW

Exercise 1

Step 1: Start by lying down with arms at sides, close to the edge of the bed. Move arm over head, as shown.

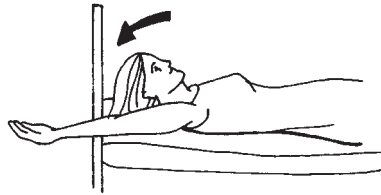

Step 1

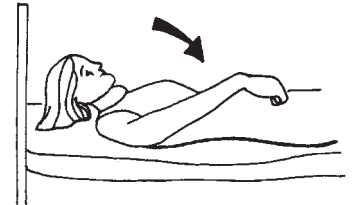

Step 2

Step 2: Return arm to start position (arm straight).

Step 3: With arm at shoulder height, reach for the ceiling, lifting the shoulder off the bed.

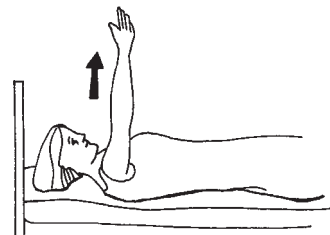

Step 3

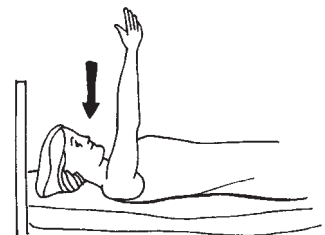

Step 4

Step 4: Draw arm and shoulder back until shoulder is flat on the bed.

Step 5: Move arm outward from the body to above the head.

Step 6: Return arm to start position (arm straight).



Step 5

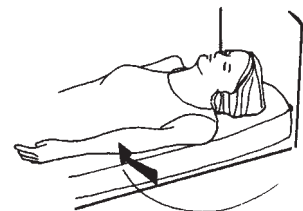

Step 6

Step 7: With arm extended outward at shoulder height, move arm down toward the floor as far as possible. Return arm to start position.

Step 8: Extend arm outward at shoulder height. Move arm across body, lifting shoulder off the bed. Return to starting position, with both arms straight.

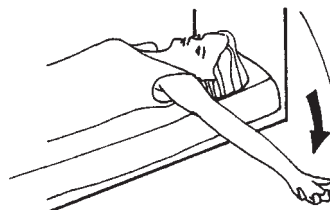

Step 7

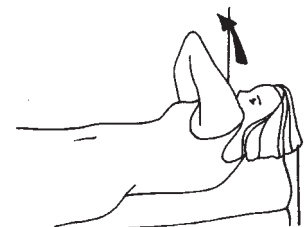

Step 8

Repeat all the above with other arm.

ELBOW AND FOREARM EXERCISES

Exercise 1

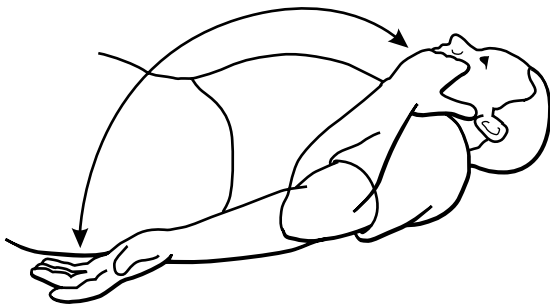

Starting position: Lie on bed or mat, arms at side, palms up.

Keeping elbow on bed or mat, bring hand as close to the shoulder as possible. Hold.

Return to start position.

Repeat 3 times on each side.

Exercise 2



Starting position: Lie on back with arms at your sides, palms turned toward body. Or sit at a table, with forearm resting on the table.

Raise forearm straight up. If lying down, keep elbow and upper arm on the bed.

Gently rotate hand, palm toward your face, palm away from your face. Repeat 2–3 times.

Repeat exercise with other arm.

HAND AND WRIST EXERCISES

Exercise 1

Step 1: Bend fingers toward palm (make a fist).

Step 2: Straighten fingers.

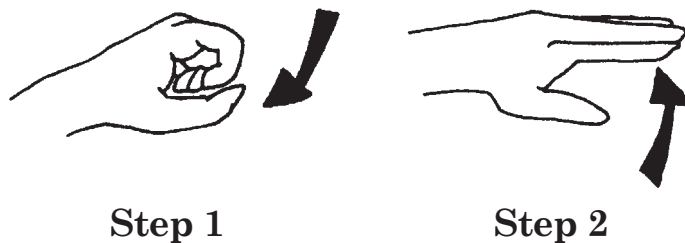

Exercise 2

Step 1: Bend thumb at all joints.

Step 2: Straighten thumb.

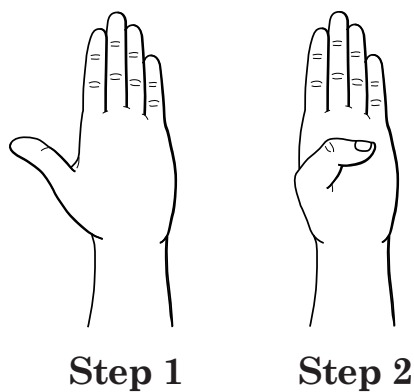

Exercise 3

Step 1: Move fingers apart (spread fingers).

Step 2: Move fingers together.

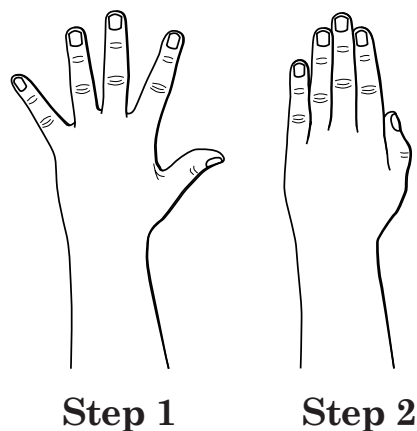

HAND AND WRIST EXERCISES

Exercise 4

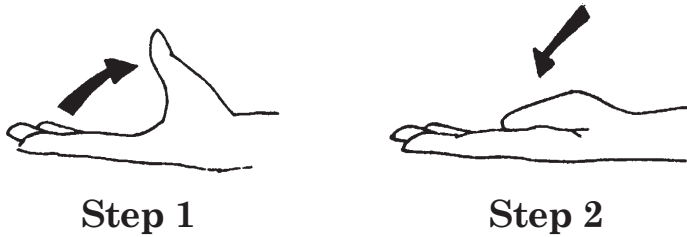

Step 1: With palm up, move thumb up and away from palm.

Step 2: Return thumb to position along side of first finger.



Step 3: Move thumb out and around to touch little finger.

Exercise 5

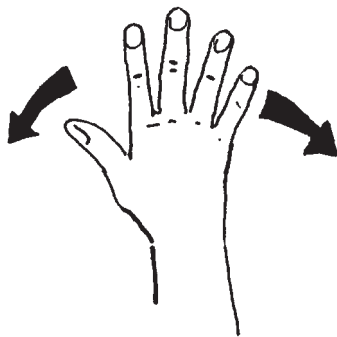

With hand out flat, keeping arm still, move hand first to the left, then to the right.

SUGGESTION

To improve finger coordination, try playing board games, building models, or doing crafts.

HAND AND WRIST EXERCISES

Exercise 6

Step 1: Bend wrist so that palm is toward forearm.



Step 1

Step 2: Straighten from bent position to neutral position.



Step 2

Step 3: Move hand so that back of hand is moved toward forearm.



Step 3

Exercise 7

Step 1: Start with arm and wrist in a comfortable position, fingers pointing to the ceiling.



Step 1

Step 2: Bend the fingers at the large knuckles, making a tabletop. Then straighten. Try to keep the wrist relaxed.



Step 2

TRUNK AND HIP EXERCISES

Exercise 1

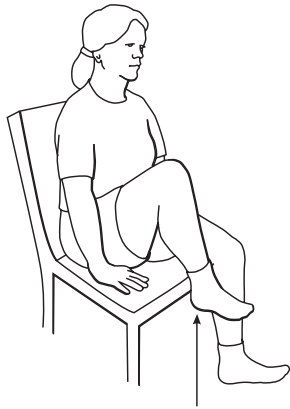

Starting position: Sit on chair or edge of bed, with feet touching floor.

Bend hip by lifting knee toward chest.

Hold, then lower foot to floor. Repeat.

Exercise 2

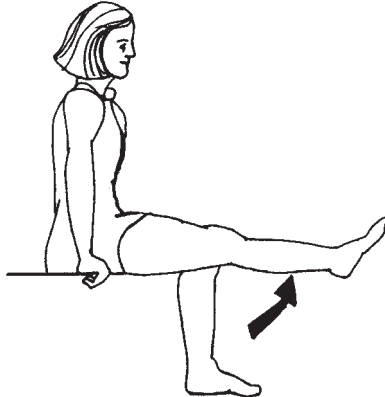

Straighten knee while lifting foot up. Return slowly to a bent knee position.

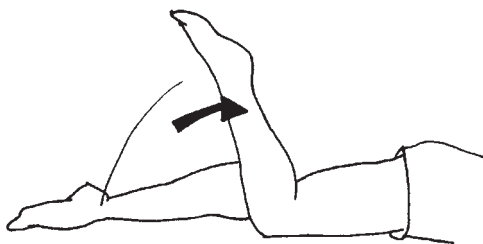

Exercise 3

Lie on stomach, bend knee. Return to original position.

TRUNK AND HIP EXERCISES

Exercise 4

Step 1: Lying on your back, turn your leg out so that toes point away from your other leg.

Step 2: Turn your leg so that toes point toward your other leg.

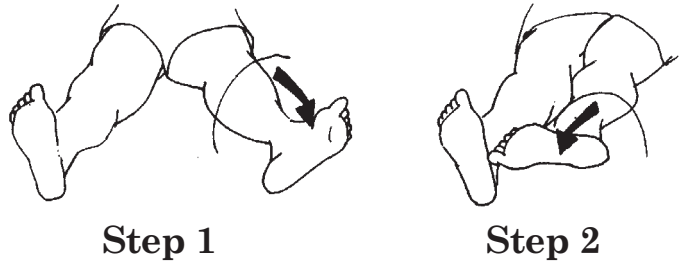

Exercise 5

With legs together and straight, move legs apart from each other and return to the neutral position. Or move one leg at a time out and then back to the starting position.

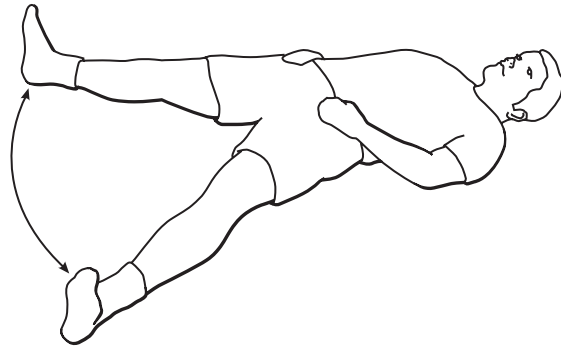

Exercise 6

Bend one leg at the knee, keeping the foot flat on the mat. Slowly move the other leg up 6–10 inches off the mat without bending the knee. Lower slowly and repeat.

(Note: If lower back is very weak, slide hands, palms down, under the small of the back before lifting the leg.)

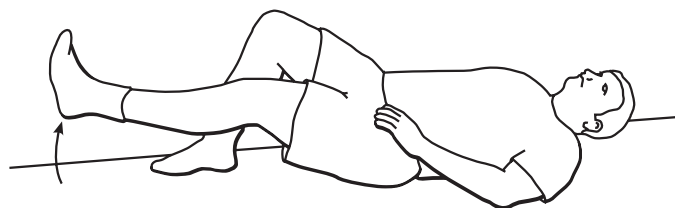

TRUNK AND HIP EXERCISES

Exercise 7

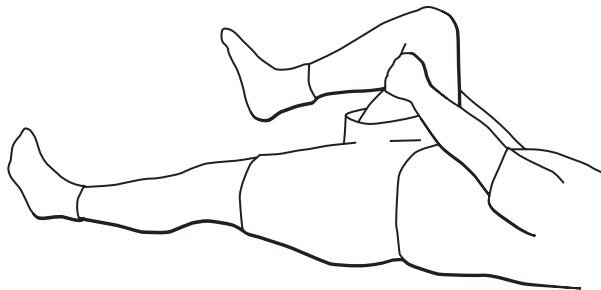

Lying on back, pull one knee up and hug toward chest. Keep the other leg flat on floor or bed. If this stretch is too hard, hold the thigh behind the knee with both hands. If this is too hard, stand one leg on the floor and slide the heel toward the buttock. Do each side.

Exercise 8



Lying on back with knees bent and feet flat, slowly lower knees from side to side. The goal is to stretch the trunk and hips, not to touch the knees to the floor or bed.

Exercise 9

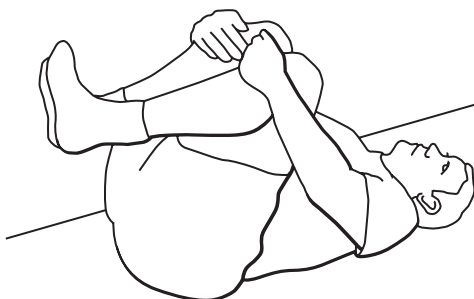

Pull one knee up and then the other to hug them to chest for a low back stretch. After the stretch, set one foot down and then the other to prevent any strain to the low back.

ANKLE AND FOOT EXERCISES

Exercise 1

Step 1: Move foot up and toward the leg.

Step 2: Move foot down and away from the leg. Do this slowly. If it feels as if it may cause a muscle spasm, repeat Step 1 and hold gently. Then stop.

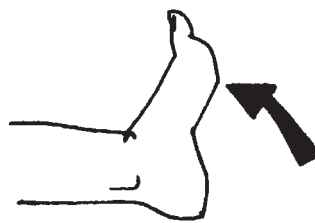

Step 1

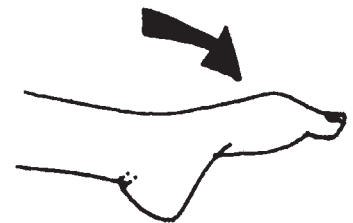

Step 2

Exercise 2

Step 1: Move foot so sole is facing outward.

Step 2: Move foot so sole is facing inward, then repeat, reversing direction.

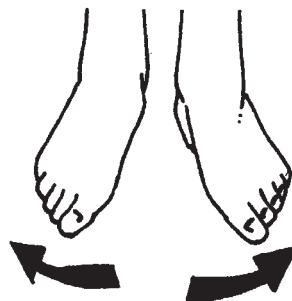

Step 1

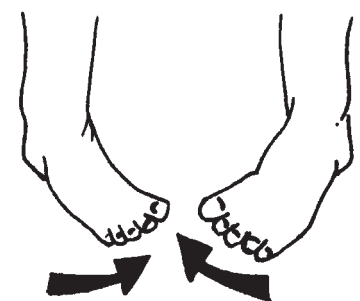

Step 2

Exercise 3

Step 1: Bend toes toward ball of foot.

Step 2: Straighten toes and pull them toward the shinbone as far as possible.



Step 1



Step 2

ANKLE AND FOOT EXERCISES

Exercise 4

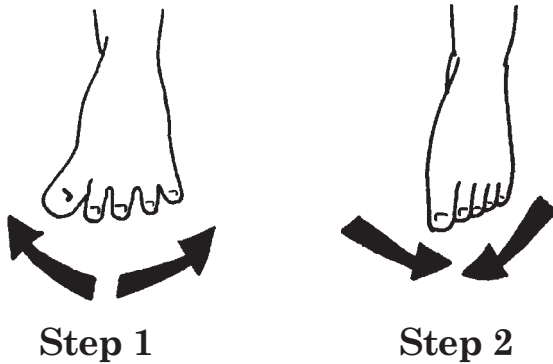

Step 1: Move toes apart.

Step 2: Move toes together.

Exercise 5

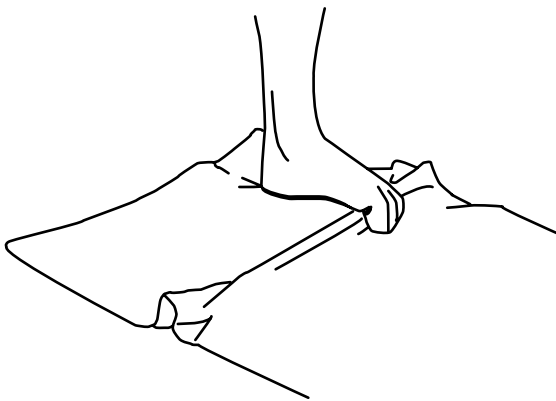

To exercise the toes and foot, pick up a dry washcloth from the floor and open toes to drop it again.

SITTING COORDINATION AND BALANCE

These exercises are appropriate for people who can sit safely without support on the edge of a bed or chair.

Exercise 1

Maintain your balance keeping your arms on your lap. If possible, lift up one leg, then the other, as shown. If not, slide one heel forward and back on the floor.

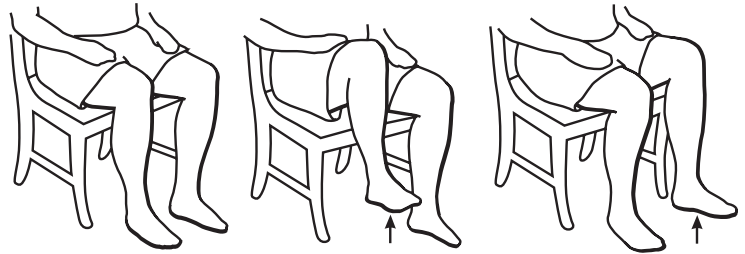

Exercise 2

With your arms at your side and elbows bent to 90 degrees, turn right hand so that your palm faces up. Turn your left hand so that your palm faces down. Then simultaneously switch so that right-hand palm is now down and left-hand palm is up. Repeat in rapid succession.

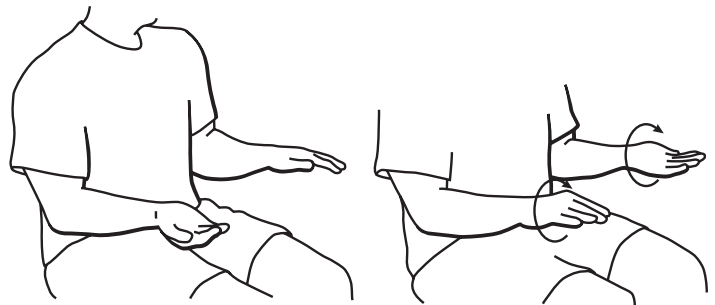

Exercise 3

Start with both hands in the middle of your chest. Bring one arm up and forward while simultaneously stretching your other arm back. Then return to original position and repeat in opposite direction. Try repeating sequence 5 times.

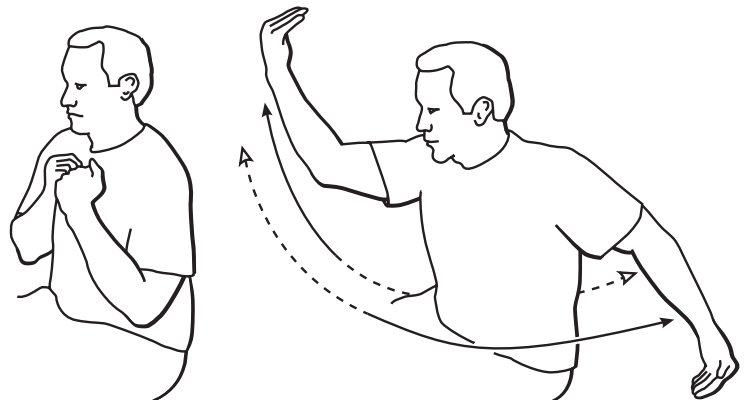

CAUTION

If you have any balance problems or “unsteadiness”, DO NOT do these exercises without first consulting your physician/physical therapist.

POSITIONING FOR SPASTICITY

Spasticity

Spasticity can be defined as a tightening or stiffness of the muscle due to increased muscle tone, and is often made worse when muscles are quickly stretched or moved. However, exercise, properly done, is vital in managing spasticity.

The following tips may prove helpful:

1. Avoid positions that make your spasticity worse.
2. Exercises that slowly stretch the muscles to their full lengths may help.
3. Keep in mind that moving a spastic muscle to a new position may result in an increase in spasticity. If this happens, allow a few minutes for the muscles to relax.
4. When exercising, try to keep your head straight (not tilted to one side).
5. If you are using an antispastic drug, time exercise to begin approximately one hour after taking the medication.
6. Your antispastic drug dose should be checked frequently, as spasticity changes.
7. Sudden changes in spasticity may occur in the presence of infections, skin sores, or even tight shoes or clothing.

POSITIONING FOR SPASTICITY

Flexor spasticity

Common in people with multiple sclerosis. The hips and knees are maintained in a bent position with hips turned inward. Less frequently, hips and knees are turned outward. Knees are bent in a flexed position and feet tend to point in a downward direction.

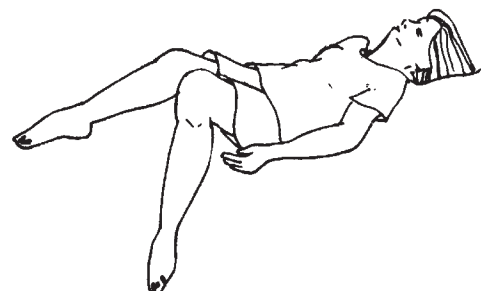

Extensor spasticity

Less common. The hips and knees are maintained in a straightened position, and the legs are very close together or crossed over, with the feet in a downward position.



Keep in mind

Keep in mind that you want to refrain from active exercises that accentuate a position associated with any spasticity you experience. For example, if you have extensor spasticity, refrain from doing the active exercises that straighten the hip and knee.

It is important to remember that the positions in this section are designed to decrease your spasticity. If they do not, consult your physician or physical therapist.

POSITIONING FOR SPASTICITY

Positioning your body to reduce spasticity

1. Lying on your stomach (prone position)

This is an excellent position to try if you have spastic hip and knee flexors. Remember, give yourself a few minutes to allow your hip muscles to relax in this new position. If able, let toes and foot hang over edge of bed to allow a neutral ankle position. As your hips relax, so will your calf muscles.

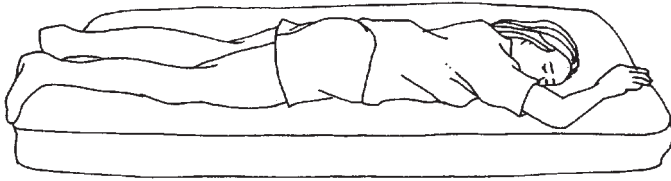

2. Lying face up (supine position)

If your knees tend to roll inward, try placing a rolled pillow or towel between your knees. Again, allow time for your legs to accommodate and relax in the new position for a few minutes. Pillows under the knees only reinforce the knee flexion and should be avoided.

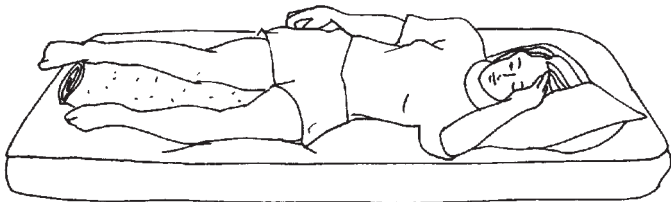

3. Lying on your side (side-lying)

This is an excellent position if your hips and knees are prone to extensor spasticity. On your side, bend the knee of your top leg and let the knee of your bottom leg be straight. You can also put a rolled pillow or towel between your legs.

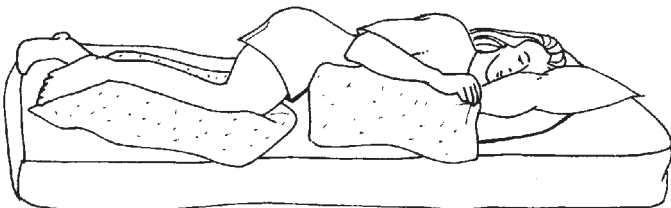

POSITIONING FOR SPASTICITY

4. Correcting hip turn out

If your hips and knees assume a “frog like” position due to spasticity, try lying on your back. Place the end of a pillow, or a large beach towel, under your upper thigh (hip to knee). Roll the towel or pillow so that your hips and knees align themselves. Knees should be pointed toward the ceiling.

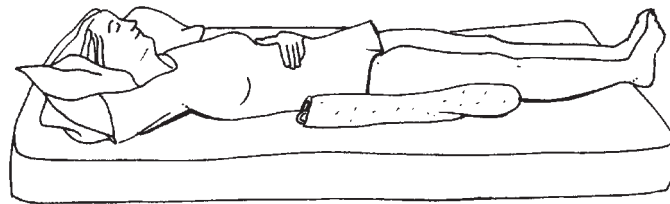

5. Correcting foot turn down

If your ankles and feet turn in a downward position, you want to try to position your ankles and feet in a neutral position—that is, with your toes pointed up toward the ceiling. The easiest way to achieve this is to place your feet against a padded footrest. One can easily be constructed if your bed does not have one. Or you could ask your therapist or physician about resting ankle splints.

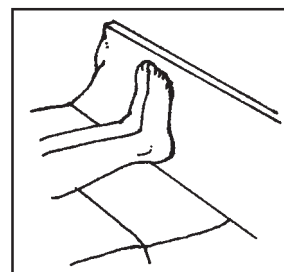
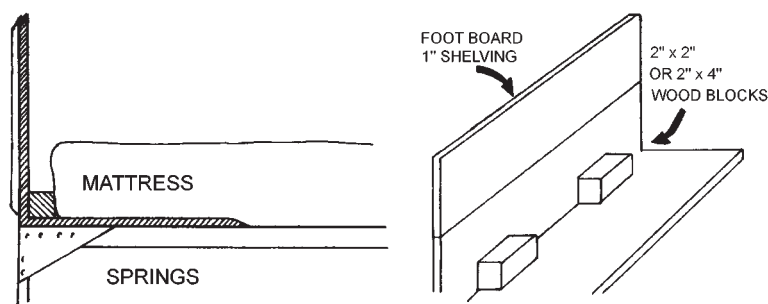

6. Correcting bent elbows

If your elbows tend to bend, and your arms remain close to your body, try lying down with your arms out alongside your body, on pillows, and your hands positioned palms down.

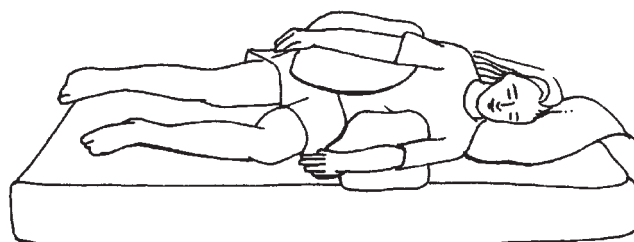

INDEX OF SPECIAL TERMS

Your physician or physical therapist may use the following technical terms:

Range of Motion: extent of movement that is possible within a joint.

Passive Range of Motion: extent of motion possible in a joint when moved with assistance (i.e., by a therapist, helper, or a piece of machinery).

Active Range of Motion: extent of movement that is possible in a joint when the person moves without assistance.

Spasticity: a tightening or stiffness of the muscle due to increased muscle tone and exaggerated response to muscle stretch.

Joint Contractures: a fixed limitation in the range of motion that impairs the function of a joint.

Disuse Muscle Atrophy: the decrease in size—and eventually in strength—of muscle fibers that have not been contracted for a period of time.

Basic Exercise Movements:

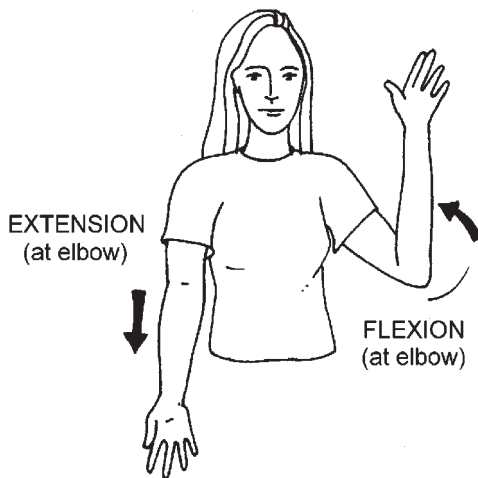

A. Flexion is the act of moving a joint so that your limb is bending.

B. Extension is the act of moving a joint so that your limb is straightening out.

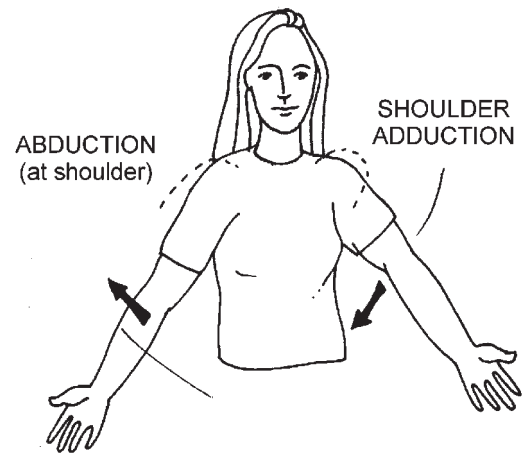

C. Abduction is the act of moving a joint so that your limb is moving away from the body.

D. Adduction is the act of moving a joint so that your limb is moving toward the body.

The National Multiple Sclerosis Society is proud to be a source of information about multiple sclerosis. Our comments are based on professional advice, published experience, and expert opinion, but do not represent individual therapeutic recommendations or prescription. For specific information and advice, consult your personal physician.

The Society publishes many other pamphlets and articles about various aspects of MS. To ask for these, or for other information, call the National MS Society at 1-800-344-4867.

*All our publications are on our Web site, along with hand-outs called "Basic Facts" on various topics. For a list, click the bar on our home page called "Living with MS"; then click "Library & Literature". If you have no access to the Internet, just call your chapter and ask for a copy of the latest **Publications List**.*

Some of our popular pamphlets include:

- ❖ Exercise as Part of Everyday Life
- ❖ Taming Stress in Multiple Sclerosis
- ❖ Managing MS Through Rehabilitation
- ❖ Living with MS



**The National Multiple Sclerosis Society
is dedicated to ending the devastating
effects of multiple sclerosis.**



**Programs and Services Department
National Multiple Sclerosis Society**

700 Broadway, Suite 810

Denver, CO 80203

Tel: (303) 813-1052

Fax: (303) 813-1513

National Web site:

nationalmssociety.org